

SOLEAL ÂNGULO, a janela de correr de ângulo para as grandes aberturas contemporâneas

CARACTERÍSTICAS

- Aplicações de base de 2 a 4 carris e de correr para dentro da parede (Galandage) até 3 carris.
- Abertura com ângulo reentrante ou saliente.
- Grandes dimensões, até L 6 m x A 2,50 m por lado, em 3 carris.
- Sistema de drenagem oculta em todas as aplicações.
- Solução de acessibilidade de acordo com a normativa PMR, disponível em todas as aplicações.

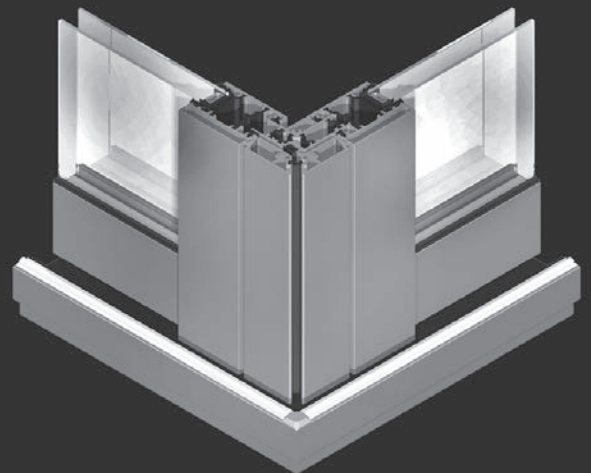

CORTES

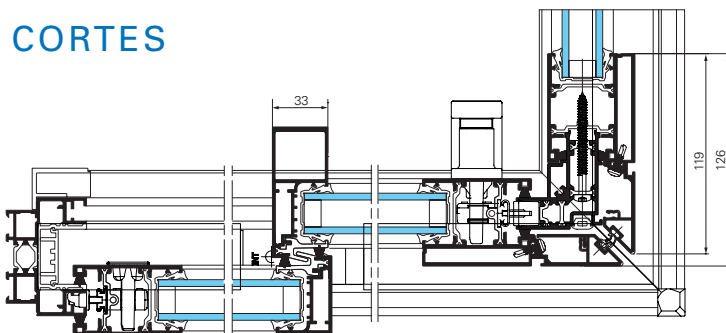

Ângulo saliente

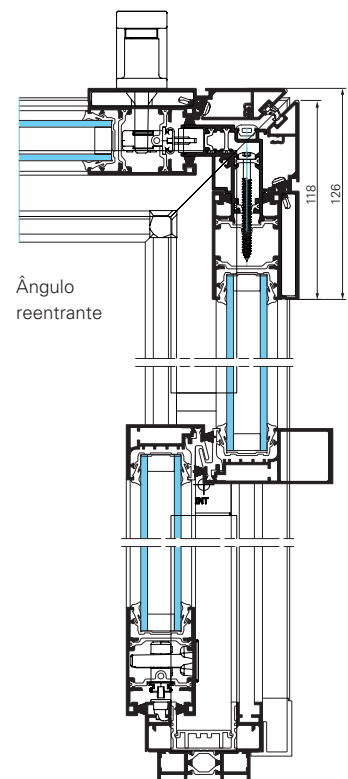

Ângulo reentrante

APLICAÇÕES

Base

Ângulo saliente

2 carris

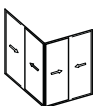

2 x 2 folhas

3 carris



2 x 3 folhas

4 carris



2 x 4 folhas

Ângulo reentrante

2 carris

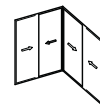

2 x 2 folhas

3 carris

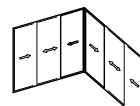

2 x 3 folhas

4 carris

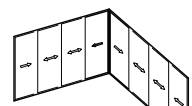







2 x 4 folhas



Fotografia: DR Technal

PERFORMANCES

	DIMENSÕES MÁXIMAS	Até L 4,30 m x A 2,60 m. Janela de sacada 2 folhas 2 carris
	PESO MÁXIMO POR FOLHA	Até 200 kg
	TÉRMICA	Uw até 1,4 W/m ² .K, Sw: 0,45 e TLw: 0,59 Vidro duplo Ug= 1,0 W/m ² .K + intercalar isolante (L 4,30 m x A 2,60 m)
	ACÚSTICA	-34 dBA (Ra, Tr) Janela de sacada 2 folhas 2 carris (L 2,35 m x A 2,18 m)
	ESTANQUIDADE	A ₄ E _{7A} V _{B2} 2 folhas 2 carris perfil soleira PMR (L 3,00 m x A 2,50 m)
	ACESSIBILIDADE	Perfil soleira PMR

Resultados de ensaios segundo as normas europeias em vigor

Galandage

Ângulo saliente

Mono-carril

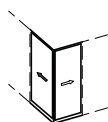

2 x 1 folha

2 carris

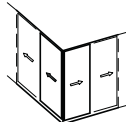

2 x 2 folhas

3 carris

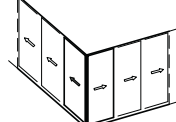

2 x 3 folhas

Ângulo reentrante

Mono-carril

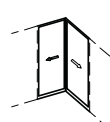

2 x 1 folha

2 carris

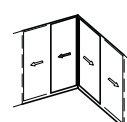

2 x 2 folhas

3 carris

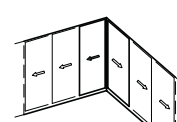

2 x 3 folhas

LUMEAL, a janela de correr minimal: o design que melhora a performance

CARACTERÍSTICAS

- Vista de alumínio reduzida com montante central de apenas 38 mm e 77 mm de alumínio visíveis.
- Grandes dimensões até L 5,00 m x A 2,70 m em porta de 2 folhas.
- Sistema de drenagem oculta em todas as aplicações.
- Perfil soleira adaptado à acessibilidade de Pessoas com Mobilidade Reduzida (PMR).
- Segurança reforçada: classe de resistência CR3 de acordo com a norma europeia EN 1627-30.

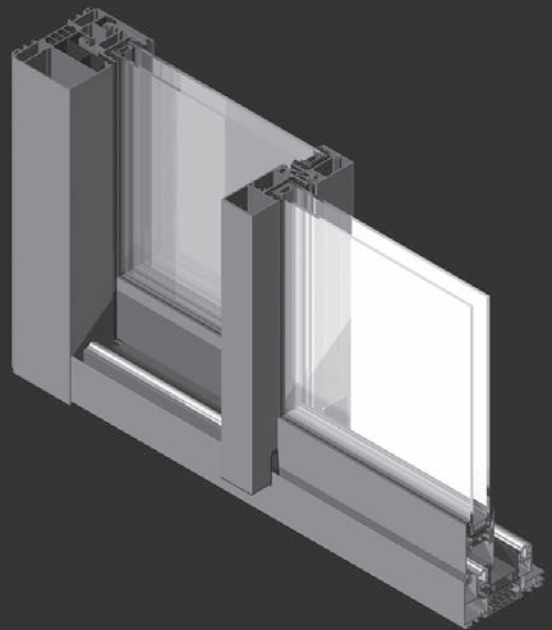

CORTES

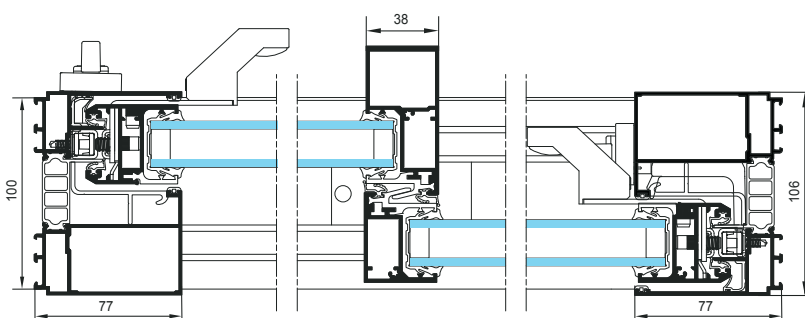

Horizontal

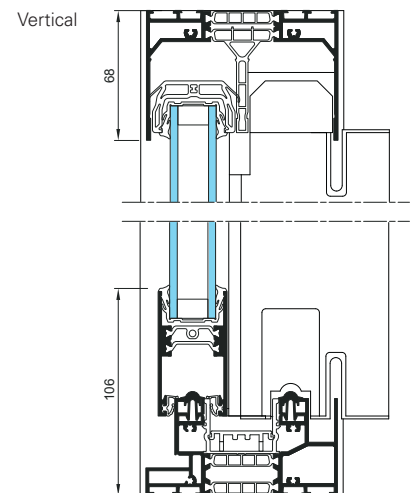

APLICAÇÕES

2 carris

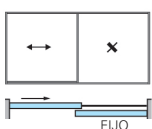

1 folha + 1 fixo

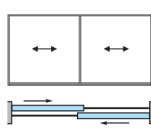

2 folhas

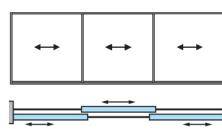

3 folhas

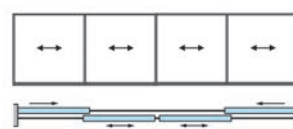

4 folhas

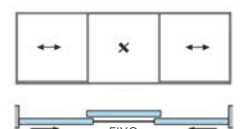







2 folhas + fixo



Arquitecto: Raimon Parera Fotografia: Eugeni Pons

PERFORMANCES

	DIMENSÕES MÁXIMAS	Até L 5,30 x A 2,70 m. Janela de sacada 2 folhas 2 carris
	PESO MÁXIMO POR FOLHA	Até 300 kg
	TÉRMICA	$U_w = 1,2 \text{ W/m}^2\cdot\text{K}$ e $S_w = 0,46$ $TL_w = 0,65$ Vidro duplo com $U_g = 1,0 \text{ W/m}^2\cdot\text{K}$ + intercalar isolante (L 4,50 m x A 2,70 m)
	ACÚSTICA	-35 dB (Ra, Tr) Janela de sacada 2 carris - 1 folha + 1 fixo (L 2,80 m x A 2,20 m)
	ESTANQUIDADE	A4 E7A VB3 Janela de sacada 1 folha + fixo (L 3,00m x A 2,50 mm)
	ACESSIBILIDADE	Perfil soleira PMR
	SEGURANÇA	Classe de resistência nível 3 contra a intrusão segundo a norma EN 1627-30

Resultados de ensaios segundo as normas europeias em vigor

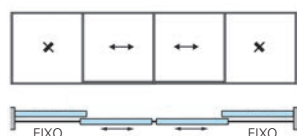

2 folhas + 2 fixos

3 carris

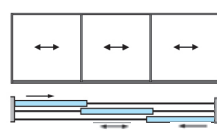

3 folhas

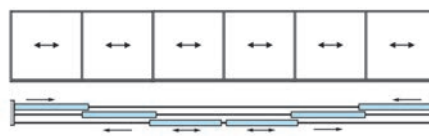

6 folhas

LUMEAL XXL, a janela de correr minimal para espaços de dimensões fora do habitual

CARACTERÍSTICAS

- Permite a criação de espaços envidraçados de dimensões fora do comum.
- Montante central reforçado que assegura uma resistência ao vento elevada.
- Os perfis superior e laterais podem ser ocultados em obra pela parte exterior.

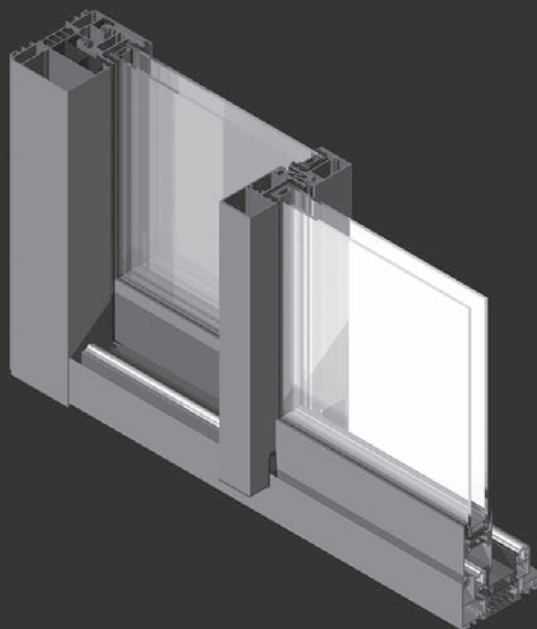

CORTES

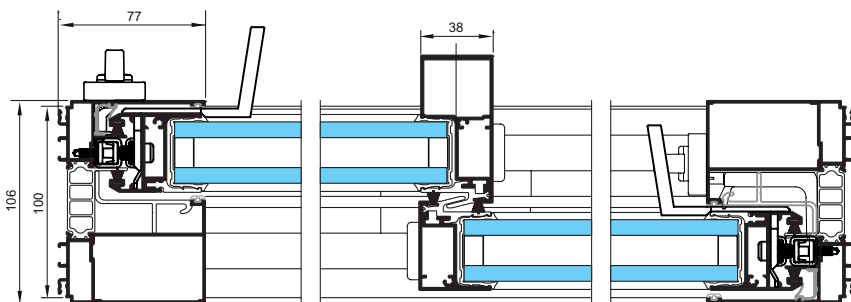

Horizontal

Vertical

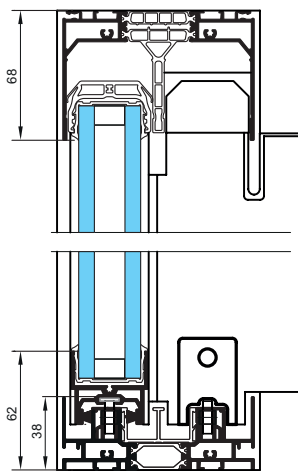

APLICAÇÕES

2 carris

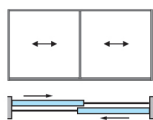

2 folhas

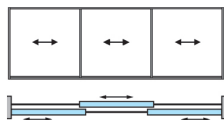

3 folhas

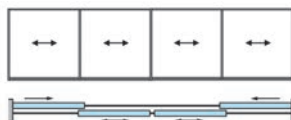







4 folhas



Arquitecto: Tibor Martín Fotografia: Jordi Canosa

PERFORMANCES

	DIMENSÕES MÁXIMAS	Até L 6,00 x A 3,00 m. Janela de sacada 2 folhas 2 carris
	PESO MÁXIMO POR FOLHA	Até 600 kg
	TÉRMICA	$U_w = 1,2 \text{ W/m}^2 \cdot \text{K}$ e $S_w = 0,46$ $TL_w = 0,65$ Vidro duplo com $U_g = 1,0 \text{ W/m}^2 \cdot \text{K}$ + intercalar isolante (L 4,50 m x A 2,70 m)
	ACÚSTICA	-35 dB (Ra, Tr) Janela de sacada 2 carris - 1 folha + 1 fixo (L 2,8 m x A 2,2 m)
	ESTANQUIDADE	A ₄ E _{B4} C _{C2} Janela de sacada 2 folhas 2 carris (L 2,89 m x A 2,25 m)
	ACESSIBILIDADE	Perfil soleira PMR
	SEGURANÇA	Classe de resistência nível 3 contra a intrusão segundo a norma EN 1627-30

Resultados de ensaios segundo as normas europeias em vigor

3 carris

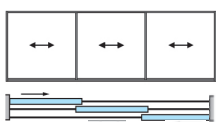

3 folhas



6 folhas